

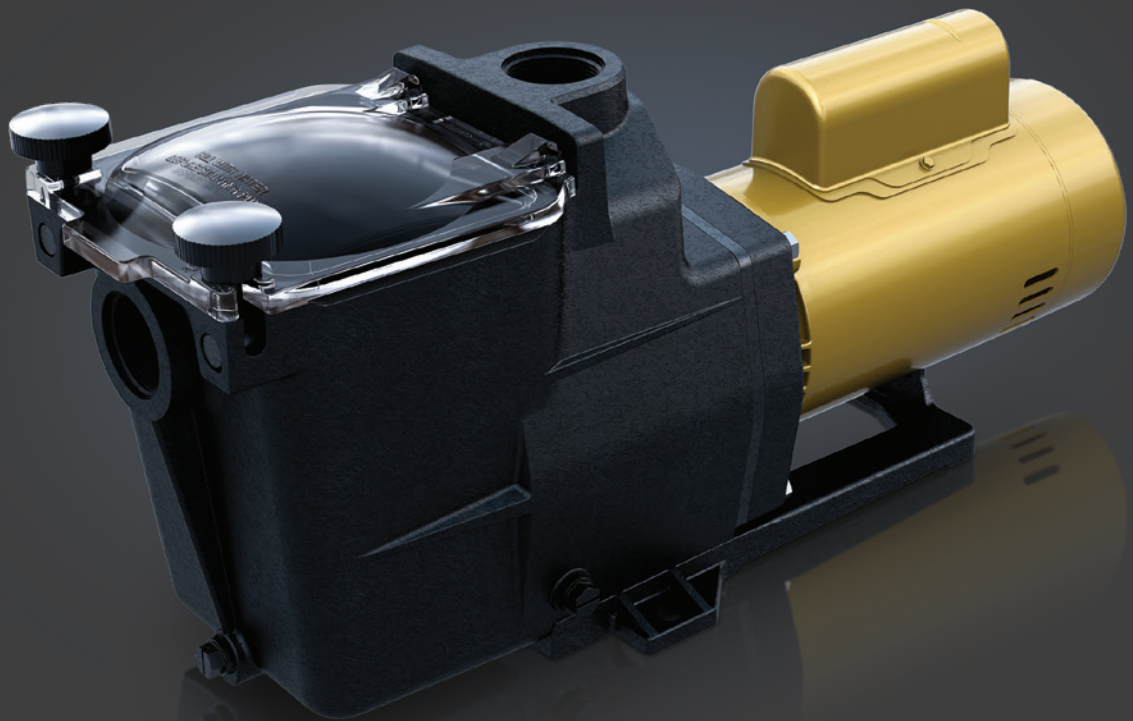

Super Pump[®]

High Efficiency Pumps

THE INDUSTRY'S MOST
TRUSTED WORKHORSE



EXPERT LINE[®]



ONLY FROM POOL PROS



3+ YEAR PARTS & LABOR WARRANTIES*

*When sold by a Totally Hayward[®] Partner. Exclusions, other terms and conditions may apply — visit hayward.com/expert for details.

PROVEN PERFORMANCE FOR POOLS OF ALL SIZES AND TYPES.

Hayward Super Pump high efficiency pumps set the industry standard for excellence and value while also meeting DOE efficiency regulations. Their heavy-duty, high-performance motor and airflow ventilation provide quieter, cooler, more efficient operation for virtually any pool or spa, while their exclusive service-ease design offers quick 4-bolt access to all internal components. With these and other advanced features, it's easy to see why Super Pump is the industry's most trusted workhorse.

Exclusive swing-away hand knobs make for easy strainer cover removal without tools

Extra-large debris basket provides added leaf-holding capacity for less frequent maintenance

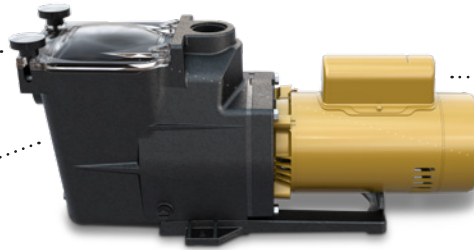

Superior pump efficiency meets Department of Energy (DOE) regulations

See-through strainer cover lets you see when the basket needs cleaning

EXPERT LINE
ONLY FROM POOL PROS

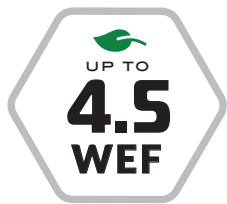

SPECIFICATIONS

MODEL NUMBER	TOTAL HP	PORT SIZE	PUMP SPEED	VOLTAGE	DIMENSION "A"	WEIGHTED ENERGY FACTOR (WEF)*
SP2600X5	0.60	2 in.	Single-Speed	230V/115V	14¼ in	4.3
SP2605X7	0.85	2 in.	Single-Speed	230V/115V	14¼ in	3.9
SP2607X10	1.10	2 in.	Single-Speed	230V/115V	14½ in	3.4
SP2607X102S	1.00	2 in.	Two-Speed	230V	13¾ in	4.5

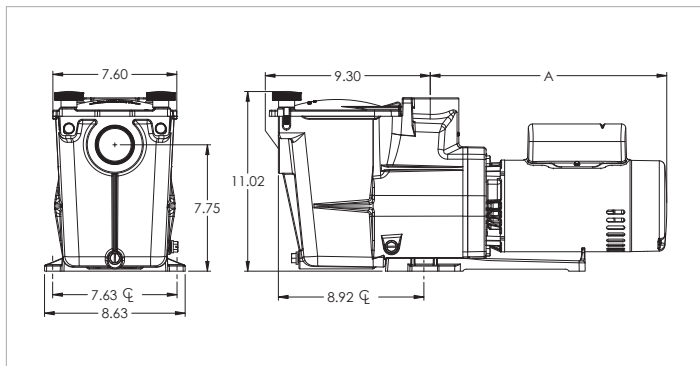

*The higher the weighted energy factor (WEF), the more efficient the pump. Visit hayward.com/regulations for more information.

SUPER PUMP SERIES DIMENSIONS (INCHES)

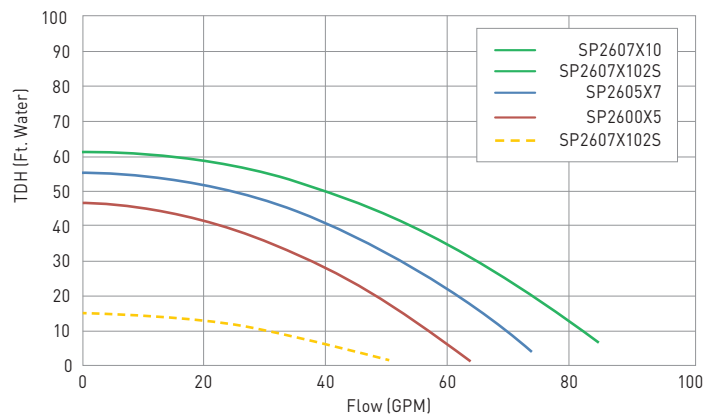

SUPER PUMP FLOW VS. TOTAL HEAD



Super Pump series pumps are listed by:   

**When sold by a Totally Hayward® partner. Exclusions, other terms and conditions may apply — visit hayward.com/expert for details.

» hayward.com » 1-888-HAYWARD

Pumps » Filters » Heaters » Sanitization » Automation » Lighting » Water Features » Cleaners » Safety

Hayward, Hayward & Design, the H logo, Expert Line, Super Pump, Totally Hayward and We Build Better. are registered trademarks of Hayward Industries, Inc. All other trademarks not owned by Hayward are the property of their respective owners. Hayward is not in any way affiliated with or endorsed by those third parties. © 2023 Hayward Industries, Inc.

LITSPHE23

