



Pro Logic[®]

Automation and Chlorination

Installation Manual



Contents

Introduction.....	2
Pool Chemistry.....	4
Installation.....	7
Configuration.....	23
Warranty.....	38

PL-P-4

Hayward Industries
400 Connell Drive, Suite 6100
Berkeley Heights, NJ 07922
Phone: (908) 355-7995
www.hayward.com



HAYWARD®

IMPORTANT SAFETY INSTRUCTIONS

When using this electrical equipment, basic safety precautions should always be followed, including the following:

- **READ AND FOLLOW ALL INSTRUCTIONS**
- **WARNING:** Disconnect all AC power during installation.
- **WARNING:** Water in excess of 100 degrees Fahrenheit may be hazardous to your health.
- **WARNING:** To reduce the risk of injury, do not permit children to use this product unless they are closely supervised at all times.
- **WARNING:** Do not use the Pro Logic to control fire pits or related equipment.
- A green colored terminal marked "Earth Ground" is located inside the wiring compartment. To reduce the risk of electric shock, this terminal must be connected to the grounding means provided in the electric supply service panel with a continuous copper wire equivalent in size to the circuit conductors supplying the equipment.
- A wire connector is provided on this unit to connect a minimum 8 AWG (8.4 mm) solid copper conductor between this unit and any metal equipment, metal enclosures of electrical equipment, metal water pipe, or conduit within 5 feet (1.5m) of the unit, to connect the equipment assembly or spa to a circuit protected by a ground-fault circuit-interrupter.

SAVE THESE INSTRUCTIONS



HAYWARD®

Introduction

What's Included

Before attempting to install the Pro Logic system, check that the following components have been included in the package:

Pro Logic Electronics Unit
(3) Temperature sensors with 15 ft. (5m) cable, hose clamp

What's NOT Included

Some of the additional items that you may need to complete an installation include:

Circuit breakers

None are included with control—see page 13 and inside of door for suitable breakers

Wire

4-conductor cable (electronics unit to remote display/keypad)
Wire/conduit for 100A service from main panel to Pro Logic
Wire/conduit for filter pump and other high voltage loads
Wire for bonding

Miscellaneous

Utility electrical outlet and weatherproof cover (for mounting on side of Pro Logic)
Mounting hardware (screws, etc.) for mounting Pro Logic and remote display/keypad
Valves (use standard Hayward, Pentair/Compool, or Jandy valves)
Additional valve actuators

Accessory Products - Order Separately

T-CELL-3	Chlorinator Cell (for pools up to 15k gallons)
T-CELL-9	Chlorinator Cell (for pools up to 25k gallons)
T-CELL-15	Chlorinator Cell (for pools up to 40k gallons)
P-KIT	Chlorination plumbing kit containing flow switch and cell unions
AQL-CHEM	ORP & sense kit
AQL-CHEM2(-240)	pH dispense kit
AQL-WW-P-4	Wired Wall Mount Remote Display
AQL-SS-6B-x (x=W/B)	Wired Spa Side 6 Function Remote Control, 150ft cable, specify color (white or black)
AQL2-POD	Handheld Wireless Waterproof Remote with Charging Station (AQL2-BASE-RF required)
AQL2-Tx-RF-P-4	Wireless Table Top remote (AQL2-BASE-RF required)
AQL2-SS-RF	Wireless Spa Side Remote Control (AQL2-BASE-RF required)
AQL2-BASE-RF	Base Receiver
AQL-DIM	Light Dimmer Relay
GVA-24	Valve Actuator
V&A-xx	Valve & Actuator (xx=1P (1.5" pos. seal), -2P (2" pos. seal))

NOTE: Before installing this product as part of a saline water purification system in a pool or spa using natural stone for coping or for immediately adjacent patios/decking, a qualified stone installation specialist should be consulted regarding the appropriate type, installation, sealant (if any)



HAYWARD®

and maintenance of stone used around a saline pool with an electronic chlorine generator in your particular location and circumstances.

NOTE: The use of dry acid (sodium bisulfate) to adjust pool pH is discouraged especially in arid regions where pool water is subject to excessive evaporation and is not commonly diluted with fresh water. Dry acid can cause a buildup of by-products that can damage your chlorinator cell.

Installation Steps

Details on each installation step are presented on the following pages:

1. Prepare the pool water (page 4)
 - General Water Chemistry
 - Salt
2. Mounting the equipment (page 7)
 - Pro Logic main unit
 - Temperature sensors
 - Remote display/keypad (optional)
 - Valve actuators (if applicable)
3. Plumbing (page 10)
 - General Pool Equipment
 - Turbo Cell
 - Flow Switch
4. Electrical Wiring (page 12)
 - Main service
 - Grounding and bonding
 - Circuit breakers
 - Pro Logic control power
 - High Voltage pool equipment
 - Low voltage wiring (temperature sensors, flow switch, etc.)
5. Pro Logic control configuration (page 23)
6. System Startup and checkout (page 36)



Pool Chemistry

Salt is required only if you are using the chlorinator features on the Pro Logic Control. If you are NOT using the chlorinator, it is recommended that you follow all of the other chemistry recommendations besides salt. Refer to the description of the Pro Logic configuration menu for information on enabling/disabling the chlorinator (see page 23).

Water Chemistry

The table below summarizes the levels that are recommended by the Association of Pool and Spa Professionals (APSP). The only special requirements for the Pro Logic are the salt level and stabilizer.

CHEMICAL	IDEAL LEVELS
Salt	2700 to 3400 ppm
Free Chlorine	1.0 to 3.0 ppm
pH	7.2 to 7.8
Cyanuric Acid (Stabilizer)	Outdoor pools - 30 to 50 ppm Indoor pools - 0 ppm
Total Alkalinity	80 to 120 ppm
Calcium Hardness	200 to 400 ppm
Metals	0 ppm
Saturation Index	-.2 to .2 (0 best)

Saturation index

The saturation index (Si) relates to the calcium and alkalinity in the water and is an indicator of the pool water “balance”. Your water is properly balanced if the Si is 0 ± 0.2 . If the Si is below -0.2 , the water is corrosive and plaster pool walls will be dissolved into the water. If the Si is above $+0.2$, scaling and staining will occur. Use the chart below to determine the saturation index.

$$Si = pH + Ti + Ci + Ai - TDS$$

°C	°F	Ti	Hardness Calcium	Ci	Total alkalinity	Ai	Total Dissolved Solids	TDS
12	53	0.3	75	1.5	75	1.9	0-1000	12.10
16	60	0.4	100	1.6	100	2.0		
			125	1.7	125	2.1	1001-2000	12.29
19	66	0.5	150	1.8	150	2.2		
			200	1.9	200	2.3	2001-3000	12.35
24	76	0.6	250	2.0	250	2.4		
			300	2.1	300	2.5	3001-4000	12.41
29	84	0.7	400	2.2	400	2.6		
			600	2.4	600	2.8		
34	94	0.8	800	2.5	800	2.9	4001-5000	12.44

Use: Measure the pH of the pool water, the temperature, water hardness, total alkalinity, and total dissolved solids. Use the table above to determine Ti, Ci, Ai, and TDS in the formula shown above. If the Si is equal to 0.2 or more, stains may appear. If the Si is equal to -0.2 or less, corrosion or deterioration may occur.

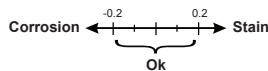



HAYWARD®

The pool's chemistry must be balanced BEFORE activating the Pro Logic's optional chlorinator function. *NOTE: If the pool does not have new water, add metal remover and non-copper based algaecide to the pool, per manufacturer's instructions. This ensures a quick, troublefree transfer to the Pro Logic system.*

Salt (When using optional chlorinator function) Salt Level

Use the chart below to determine how much salt in pounds or (Kgs) should be added to reach the recommended levels. Use the Pool Sizing Formula on page 6 (measurements are in feet/gallons and meters/liters) if pool size is unknown.

The operating salt level is between 2700-3400 PPM (parts per million) with 3200 PPM being optimal. Before adding any salt, test the salt level. This is especially important for retrofit installation to older pools where all of the chlorine added to the pool over time is ending up as salt. If the level is low, determine the number of gallons in the pool and add salt according to the chart below. A low salt level will reduce the efficiency of the sanitization and result in low chlorine production. A high salt level can cause the Pro Logic to stop chlorinating. The salt in your pool/spa is constantly recycled and the loss of salt throughout the swimming season should be minimal. This loss is due primarily to the addition of water because of splashing, backwashing, or draining (because of rain). Salt is not lost due to evaporation.

POUNDS and (Kg) OF SALT NEEDED FOR 3200 PPM

Current salt level ppm	Gallons and (Liters) of Pool/Spa water																
	8,000 (30,000)	10,000 (37,500)	12,000 (45000)	14,000 (52,500)	16,000 (60,000)	18,000 (67,500)	20,000 (75,000)	22,000 (82,500)	24,000 (90,000)	26,000 (97,500)	28,000 (105,000)	30,000 (112,500)	32,000 (120,000)	34,000 (127,500)	36,000 (135,000)	38,000 (142,500)	40,000 (150,000)
0	213 (97)	267 (121)	320 (145)	373 (170)	427 (194)	480 (218)	533 (242)	587 (267)	640 (291)	693 (315)	747 (339)	800 (364)	854 (388)	907 (412)	960 (436)	1013 (460)	1067 (484)
200	200 (91)	250 (114)	300 (136)	350 (159)	400 (182)	450 (205)	500 (227)	550 (250)	600 (273)	650 (295)	700 (318)	750 (341)	800 (363)	850 (385)	900 (408)	950 (430)	1000 (453)
400	187 (85)	233 (106)	280 (127)	327 (148)	373 (170)	420 (191)	467 (212)	513 (233)	560 (255)	607 (278)	653 (297)	700 (318)	747 (339)	793 (360)	840 (382)	887 (403)	933 (424)
600	173 (79)	217 (98)	260 (118)	303 (138)	347 (158)	390 (177)	433 (197)	477 (217)	520 (236)	563 (256)	607 (276)	650 (297)	693 (317)	737 (337)	780 (358)	823 (378)	867 (398)
800	160 (73)	200 (91)	240 (109)	280 (127)	320 (145)	360 (164)	400 (182)	440 (200)	480 (218)	520 (236)	560 (255)	600 (273)	640 (291)	680 (310)	720 (328)	760 (346)	800 (364)
1000	147 (67)	183 (83)	220 (100)	257 (117)	293 (133)	330 (150)	367 (167)	403 (183)	440 (200)	477 (217)	513 (233)	550 (250)	587 (267)	623 (283)	660 (300)	697 (317)	733 (333)
1200	133 (61)	167 (76)	200 (91)	233 (106)	267 (121)	300 (136)	333 (152)	367 (167)	400 (182)	433 (197)	467 (212)	500 (227)	533 (243)	567 (258)	600 (274)	633 (289)	667 (304)
1400	120 (55)	150 (68)	180 (82)	210 (95)	240 (109)	270 (123)	300 (136)	330 (150)	360 (164)	390 (177)	420 (191)	450 (205)	480 (218)	510 (232)	540 (246)	570 (259)	600 (283)
1600	107 (48)	133 (61)	160 (73)	187 (85)	213 (97)	240 (109)	267 (121)	293 (133)	320 (145)	347 (158)	373 (170)	400 (182)	427 (195)	453 (207)	480 (219)	507 (231)	533 (243)
1800	93 (42)	117 (53)	140 (64)	163 (74)	187 (85)	210 (95)	233 (106)	257 (117)	280 (127)	303 (138)	327 (148)	350 (159)	373 (169)	397 (180)	420 (190)	443 (201)	467 (211)
2000	80 (36)	100 (45)	120 (55)	140 (64)	160 (73)	180 (82)	200 (91)	220 (100)	240 (109)	260 (118)	280 (127)	300 (136)	320 (145)	340 (154)	360 (163)	380 (172)	400 (181)
2200	67 (30)	83 (38)	100 (45)	117 (53)	133 (61)	150 (68)	167 (76)	183 (83)	200 (91)	217 (98)	233 (106)	250 (114)	267 (121)	283 (129)	300 (147)	317 (144)	333 (152)
2400	53 (24)	67 (30)	83 (38)	93 (42)	107 (48)	120 (55)	133 (61)	147 (67)	160 (73)	173 (79)	187 (85)	200 (91)	213 (98)	227 (104)	240 (110)	253 (117)	267 (123)
2600	40 (18)	50 (23)	60 (27)	70 (32)	80 (36)	90 (41)	100 (45)	110 (50)	120 (55)	130 (59)	140 (64)	150 (68)	160 (73)	170 (77)	180 (81)	190 (86)	200 (90)
2800	27 (12)	33 (15)	40 (18)	47 (21)	53 (24)	60 (27)	67 (30)	73 (33)	80 (36)	87 (39)	93 (42)	100 (45)	107 (48)	113 (51)	120 (54)	127 (57)	133 (60)
3000	13 (6)	17 (8)	20 (9)	23 (11)	27 (12)	30 (14)	33 (15)	37 (17)	40 (18)	43 (20)	47 (21)	50 (23)	53 (24)	57 (26)	60 (27)	63 (29)	67 (30)
3200	Ideal	Ideal	Ideal	Ideal	Ideal	Ideal	Ideal	Ideal	Ideal	Ideal	Ideal	Ideal	Ideal	Ideal	Ideal	Ideal	Ideal
3400	OK	OK	OK	OK	OK	OK	OK	OK	OK	OK	OK	OK	OK	OK	OK	OK	OK
3600+	Dilute	Dilute	Dilute	Dilute	Dilute	Dilute	Dilute	Dilute	Dilute	Dilute	Dilute	Dilute	Dilute	Dilute	Dilute	Dilute	Dilute



HAYWARD®

Pool Sizing Formula

	Gallons (pool size in feet)	Liters (pool size in meters)
Rectangular	Length x Width x Average Depth x 7.5	Length x Width x Average Depth x 1000
Round	Diameter x Diameter x Average Depth x 5.9	Diameter x Diameter x Average Depth x 785
Oval	Length x Width x Average Depth x 6.7	Length x Width x Average Depth x 893

Type of Salt to Use

It is important to use only sodium chloride (NaCl) salt that is greater than 99.0% pure. This can be found at most pool stores in 40-80 lb. bags labeled "for use in swimming pools". Alternatively, use common food quality or water softener salt that is at least 99.0% pure. It is also acceptable to use water conditioning salt pellets, however, it will take longer for them to dissolve. Do not use rock salt, or salt with more than 1% of yellow prussiate of soda, salt with anti-caking additives, or iodized salt.

How to Add Salt

For new plaster pools, wait 10-14 days before adding salt to allow the plaster to cure. Turn the circulating pump on and add salt directly into the pool. Brush the salt around to speed up the dissolving process—do not allow salt to pile up on the bottom of the pool. Run the filter pump for 24 hours with the suction coming from the main drain (use pool vacuum if there is no main drain) to allow the salt to evenly disperse throughout the pool. The salt display may take 24 hours to respond to the change in salt concentration.

Always check stabilizer (cyanuric acid), when checking salt. These levels will most likely decline together. Use the chart below to determine how much stabilizer must be added to raise the level to 40 ppm.

POUNDS and (Kg) OF STABILIZER (CYANURIC ACID) NEEDED FOR 40 PPM

Current Stabilizer level (ppm)	Gallons and (Liters) of Pool Water																
	8,000 (30000)	10,000 (37500)	12,000 (45000)	14,000 (52500)	16,000 (60000)	18,000 (67500)	20,000 (75000)	22,000 (82500)	24,000 (90000)	26,000 (97500)	28,000 (105000)	30,000 (112500)	32,000 (120000)	34,000 (127500)	36,000 (135000)	38,000 (142500)	40,000 (150000)
0 ppm	2.7 (1.2)	3.4 (1.5)	4.0 (1.8)	4.7 (2.2)	5.4 (2.5)	6.0 (2.7)	6.7 (3.0)	7.4 (3.4)	8.0 (3.6)	8.7 (4.0)	9.4 (4.3)	10.0 (4.5)	10.8 (5.0)	11.4 (5.2)	12 (5.4)	12.7 (5.7)	13.4 (6)
10 ppm	2.0 (.9)	2.5 (1.1)	3.0 (1.4)	3.5 (1.6)	4.0 (1.8)	4.5 (2.0)	5.0 (2.3)	5.5 (2.5)	6.0 (2.7)	6.5 (3.0)	7.0 (3.2)	7.5 (3.4)	8 (3.6)	8.5 (3.8)	9 (4.0)	9.5 (4.3)	10 (4.6)
20 ppm	1.3 (.59)	1.7 (.77)	2.0 (.90)	2.3 (1.1)	2.7 (1.3)	3.0 (1.3)	3.3 (1.5)	3.7 (1.6)	4.0 (1.8)	4.3 (2.0)	4.6 (2.1)	4.9 (2.2)	5.4 (2.4)	5.7 (2.5)	6 (2.6)	6.3 (2.8)	6.6 (3.0)
30 ppm	0.7 (.31)	0.8 (.36)	1.0 (.45)	1.0 (.54)	1.4 (.64)	1.5 (.68)	1.7 (.77)	1.8 (.82)	2.0 (.91)	2.2 (.97)	2.4 (1.1)	2.6 (1.2)	2.8 (1.3)	2.9 (1.3)	3.0 (1.4)	3.2 (1.4)	3.4 (1.5)
40 ppm	0.0	0.0	0.0	0.0	0.0	0.0	0.0	0.0	0.0	0.0	0.0	0.0	0.0	0.0	0.0	0.0	0.0



Installation

Mounting

Pro Logic Control Center

The Pro Logic is contained in a raintight enclosure that is suitable for outdoor mounting. The control must be mounted a minimum of 5 ft. (2 meters) horizontal distance from the pool/spa (or more, if local codes require). The Control Center is designed to mount vertically on a flat surface with the knockouts facing downward. Because the enclosure also acts as a heat sink (disperses heat from inside the box), it is important not to block the four sides of the control. Do not mount the Pro Logic inside a panel or tightly enclosed area.

When selecting a location, note that the standard cables supplied with the Turbo Cell, flow switch, temperature sensors, and valve actuators (if applicable) are all 15 ft. (5m) long.

Temperature Sensors

Three sensors are included with the Pro Logic. A water sensor and an air sensor must be installed at all times for proper operation. A solar sensor is required if the solar function is enabled.

Water Sensor

This sensor is used to measure the pool/spa temperature and is installed in the filtration plumbing after the filter but before either the solar or conventionally fueled heaters—refer to the plumbing overview diagram.

1. Drill a 3/8" (10mm) diameter hole in the PVC piping and remove all chips and burrs.
2. Insert sensor until O-ring collar sits flush on the hole.
3. Position hose clamp over the sensor and gently tighten until O-ring makes an adequate seal. Do not overtighten.
4. For maximum temperature accuracy, cover the sensor and 3" (6cm) of pipe on either side with insulation and white paint.

Air Sensor

Mount the air sensor outdoors. **IMPORTANT:** Mount the air sensor out of direct sunlight.

Solar Sensor

For solar applications, mount the sensor near the solar collector array so that it is exposed to the same sunlight as the collectors. Use additional cable (20 AWG) if necessary.

Optional Chlorination Function

The PL-P-4 model requires the use of a chlorinator cell and plumbing kit to provide pool chlorination. These items are not included with the Pro Logic and can be purchased separately at your local Hayward dealer. Choose a chlorinator cell model based on the size of your pool. The following models are available:

- T-CELL-15 for pools up to 40,000 gallons
- T-CELL-9 for pools up to 25,000 gallons
- T-CELL-3 for pools up to 15,000 gallons



In addition to the chlorinator cell, a plumbing kit (P-KIT) must be purchased. This kit contains the cell unions and flow switch. Refer to pages 10 and 22 for plumbing and wiring instructions.

Optional AQL-CHEM ORP and pH Sensing Kit

The AQL-CHEM is an ORP and pH sensing kit for the Pro Logic. When chlorination is enabled (requires chlorinator cell and P-KIT), the Pro Logic senses the pool's ORP and pH levels and generates the correct amount of chlorine to keep your pool properly sanitized. Wiring and plumbing requirements for the AQL-CHEM should be considered before installing the Pro Logic. Refer to the AQL-CHEM manual for specific installation information.

Optional AQL-CHEM2 CO2 Dispensing Kit

The AQL-CHEM2 is a CO2 dispensing device that connects directly to the Pro Logic. When used with an AQL-CHEM, the Pro Logic will sense the pool's pH level and automatically dispense the correct amount of CO2 to control the pool's pH to the desired level. Wiring and plumbing requirements for the AQL-CHEM2 should be considered before installing the Pro Logic. Refer to the AQL-CHEM2 manual for specific installation information.

Optional Remote Controls

Hayward offers a variety of wired and wireless remote control options for the Pro Logic. Each model gives you the ability to control your pool's functions from a remote location, away from the Control Center.

Wired Remote Controls

Up to 3 wired remote controls can be installed. See page 20 for wiring information.

AQL-WW-P-4

The AQL-WW-P-4 display/keypad must be mounted indoors or in a weather protected area (rain should never touch the unit). The display/keypad is designed to mount onto a standard electrical utility box (same box as a single light switch, ideal for new construction) or can be mounted directly onto any wall surface. When selecting a location, note that the wire to the Pro Logic main unit must be less than 500' long. Refer to the remote's installation instructions as well as the steps below:

1. Remove display/keypad baseplate from the cover by lifting up on the cover at the lower end of the keypad. See diagram below.

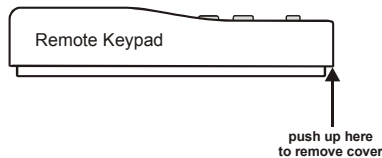

2. Screw the baseplate in the desired position (screws supplied by installer).
3. See "Electrical Wiring" (page 20) for instructions on running the cable from the Pro Logic main unit to the remote display/keypad.



HAYWARD®

AQL-SS-6B-x (x=W or B for White or Black)

The AQL-SS-6B is a double insulated, waterproof device which is intended for installation at the water's edge. The remote control comes with an attached 150' cable and is typically installed at the tile-line of the spa wall, or in the deck, within arm's reach of a pool/spa occupant. Refer to the AQL-SS-6B installation manual for specific mounting and wiring information.

Wireless Remote Controls

Note that the Pro Logic is compatible with AQL2 wireless remote controls only. A single AQL2-BASE-RF Base Station must be installed on the Pro Logic in order to use any of the Hayward wireless remote controls. With the Base Station installed, there is no limit on the number of wireless remotes that can be used. The maximum distance between the wireless remotes and the base station on the Pro Logic main control unit is 400 feet (120m) line of sight or 200 feet (60m) through walls, etc. If in doubt about the distance, test operation before installing the remote. All wireless models require the user to run the "Teach Wireless" routine in the Settings Menu. This information can be found in the Pro Logic Operation Manual and the owner's manual of each remote.

AQL2-Tx-RF-P-4

The AQL2-Tx-RF-P-4 is a portable battery operated remote control designed to be used in a weather protected area (rain should never hit the unit). This remote comes with a wall mounted power supply for recharging the built-in batteries.

AQL2-SS-RF, AQL2-POD

The AQL2-SS-RF and AQL2-POD are waterproof portable remote controls that are designed to be used in and around the pool/spa area. These units float and can be left in the water for easy access.

Optional Base Station

The AQL2-BASE-RF optional base station must be installed if any wireless remote control is used. To install the base station, remove the knockout on the upper left side of the Pro Logic main control unit, insert the base station, and then tighten the nut from the inside. Also refer to the Base Station manual and the diagram on page 20.

Optional Valve Actuators

For optional actuators used with the Pro Logic—note that the internal cams in the actuator may also have to be adjusted depending on the way the actuator is mounted on the valve and the desired valve action.

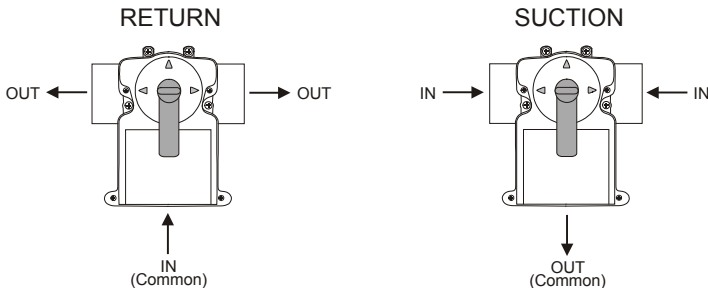



Plumbing

Pool/Spa system configuration

These systems use a single filter pump and filter. Pool or spa operation is controlled by two 3-way valves (suction and return). Refer to the diagram below.

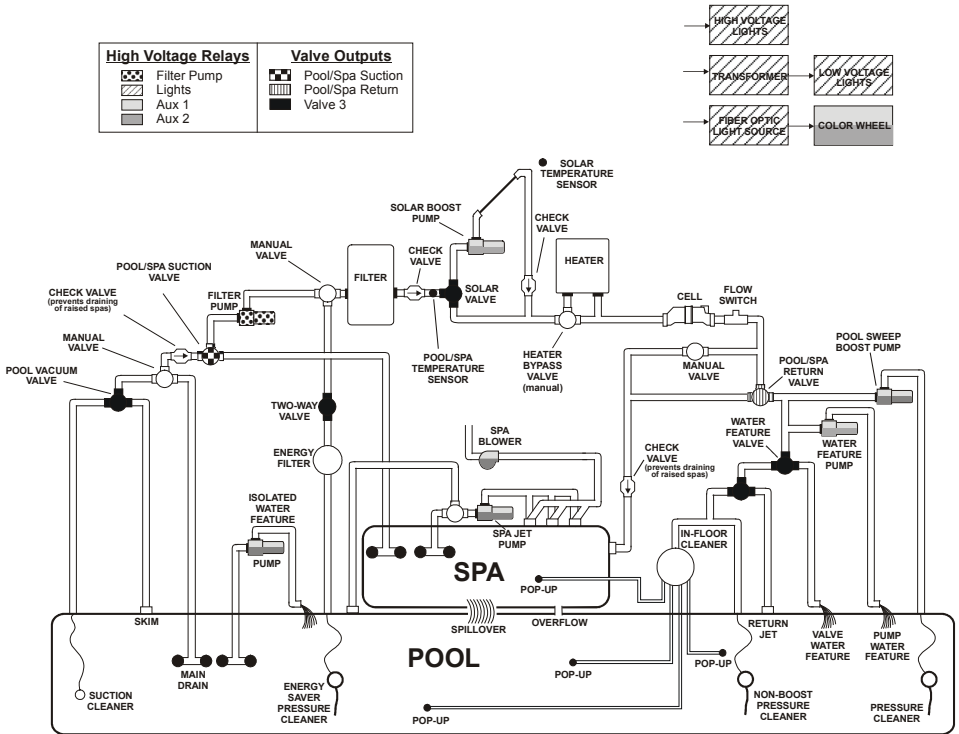

Some important notes regarding the Pro Logic control of Standard Pool/Spa systems:

1. The Pro Logic can be programmed to accommodate spa spillover, if desired.
2. A conventional heater (gas or heat pump) and solar can be used to heat both the pool and the spa.
3. If the chlorinator cell is plumbed prior to the pool/spa return valve, then both the pool and the spa can be chlorinated
4. The water sensor should be installed prior to any heater or solar and will display either the pool or the spa temperature, depending on the current operation of the pool. The temperature will only be displayed when the filter pump is running.
5. If any water feature or pressure side cleaner boost pumps are used, be sure to enable the "interlock" feature (see "Configuration Menu" for details) to ensure that the pumps operate only when the filter pump is on and the system is in the "pool only" operating mode.
6. The plumbing diagram above is intended to be used as a general guideline and is not a complete plumbing schematic for the pool.
7. The air sensor must be installed if the freeze protection feature is enabled for the filter, valves or aux outputs or if the chlorinator is enabled.



HAYWARD®

Turbo Cell (choose proper model for your pool)

The Turbo Cell (used for chlorine generation) should be plumbed AFTER the filter and heater. If installed on a pool/spa combination system, the cell should be plumbed BEFORE the pool/spa return valve in order to allow proper chlorination of both the pool and the spa. Refer to plumbing diagram below:

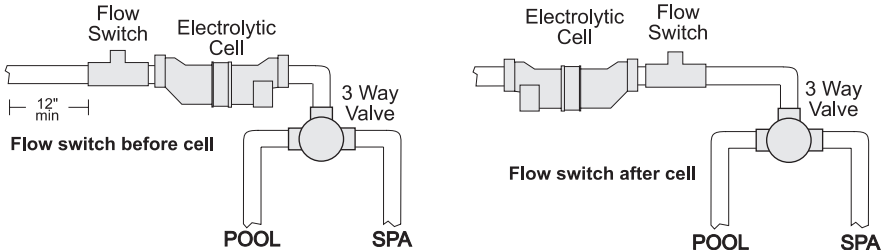

The cell may be mounted vertically or horizontally, and water can move in either direction through the cell. Install using the 2" unions provided. Tighten unions BY HAND for a watertight seal. For systems with 1½" plumbing use adaptors (provided by installer).

Flow Switch (supplied with P-KIT)

The flow switch must be plumbed in the same section of plumbing as the Turbo Cell. The flow switch is a safety device that ensures that water is flowing through the cell before the Pro Logic starts to generate chlorine. Failure to properly install the flow switch can result in explosive gases accumulating in the pool plumbing system.

IMPORTANT: There must be at least a 12" (30cm) straight pipe run before (upstream) the flow switch. If the switch is plumbed after the cell, the cell can be counted as the 12" (30cm) of straight pipe.

IMPORTANT: To ensure proper operation, verify that the arrow on the flow switch points in the direction of water flow.



HAYWARD®

Electrical Wiring

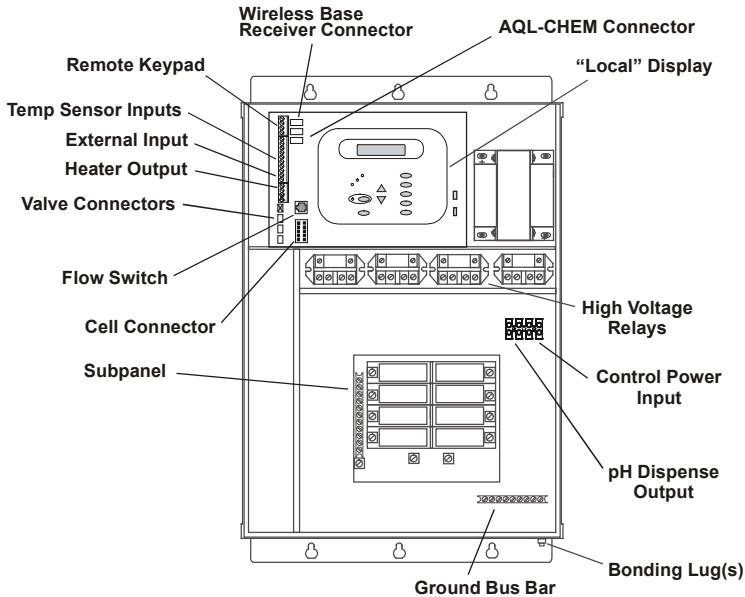

The Pro Logic Control Center requires both high and low voltage connections. Low voltage connections will be made to actuators, sensors, remote keypads, etc. High voltage connections will be made to pumps, lights, etc., as well as providing direct input power to the Control Center. Always:

- Ensure that Power is disconnected prior to doing any wiring
- Follow all local and NEC (CEC if applicable) codes
- Use copper conductors only

Main Service (Power to the Circuit Breaker Subpanel)

The Pro Logic circuit breaker subpanel is rated for 100A service. Run properly rated conductors (L1, L2, N, and ground) from the primary house electrical panel to the main power connections on the Pro Logic circuit breaker base. The connection at the main house panel should be to a 240VAC circuit breaker rated at 100A maximum.

Grounding and Bonding

Connect a ground wire from the primary electrical panel to the Pro Logic ground bus bar. Also ground each piece of high voltage (120 or 240VAC) equipment that is connected to the Pro Logic control relays or circuit breakers. The Pro Logic should also be connected to the pool bonding system by an 8AWG (6AWG for Canada) wire. A lug for bonding (2 for Canada) is provided on the outside/bottom of the Pro Logic enclosure.

Circuit Breaker Installation and Wiring

Circuit breakers are to be supplied by the installer. Refer to the circuit breaker chart on the following page for a list of suitable circuit breakers that can be used. Follow the code and the circuit breaker manufacturer's rating requirements regarding the size and temperature rating for wiring.



HAYWARD®

Note that some pool equipment may be required to be connected to ground fault circuit breakers—check local and NEC (CEC) codes.

SUITABLE LISTED BREAKERS							Tightening Torque
Manufacturer	Single	Double	Twin	Quad	GFCB	Filler Plates	
Cutler-Hammer	BR	BR	BRD	BRD	GFCB	BRFP	25lb-in
	MP-T	MP-T	MH-T	MH-T	MP-GT	LX100FP	25lb-in
Murray	QP	QP	QT	QT	QPF	QF3	25lb-in
Siemens	HOM	HOM	HOMT	HOMT	HOM-GFI	HOMFP	25lb-in
Square D	TB	TB	TBBQ	TBBQ	GFB	FP-1C-TB	25lb-in
Thomas & Betts	THQL	THQL			THQL-GF	TFH	25lb-in
G.E.							

General Purpose Outlet

If desired, a duplex receptacle with weatherproof cover (supplied by installer) may be installed in the knockouts on the lower right side of the Pro Logic enclosure. Per code, the receptacle should be a GFCI type. Alternatively, connect a standard receptacle to a GFCB.

Pro Logic Control Power

The Pro Logic requires 120VAC, 5.6A power to operate the control logic circuits and the chlorinator. This power should be connected to one of the circuit breakers.

WARNING: 120VAC only (permanent damage if connected to 240V)

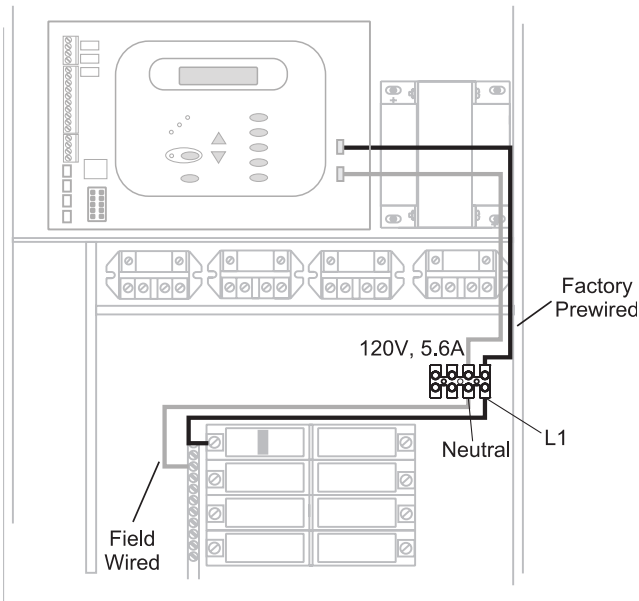



HAYWARD®

High Voltage (120/240V) Pool Equipment

All Pro Logic relays are double pole (they make/break both “legs” of 240V circuits) and are rated at 3HP/30A at 240V (1½HP/30A at 120V). Refer to the diagram below for typical relay wiring.

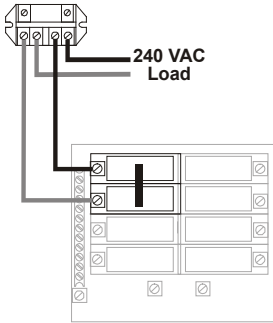

Wiring relays for 240 VAC Pool Equipment

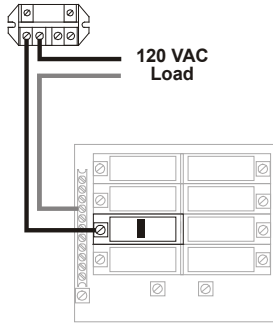

Wiring relays for 120 VAC Pool Equipment

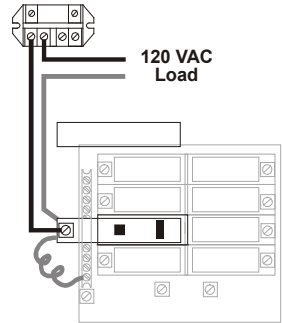

Wiring GFCB for 120 VAC Pool Equipment

WARNING: Do not use the Pro Logic to control an automatic pool cover. Swimmers may become entrapped underneath the cover.

Two speed filter pump: Requires 2 relays (FILTER plus one of the AUX relays) for proper operation of both speeds. **IMPORTANT:** Be sure to follow the wiring diagram below AND to configure the control logic according to the instructions on page 25.

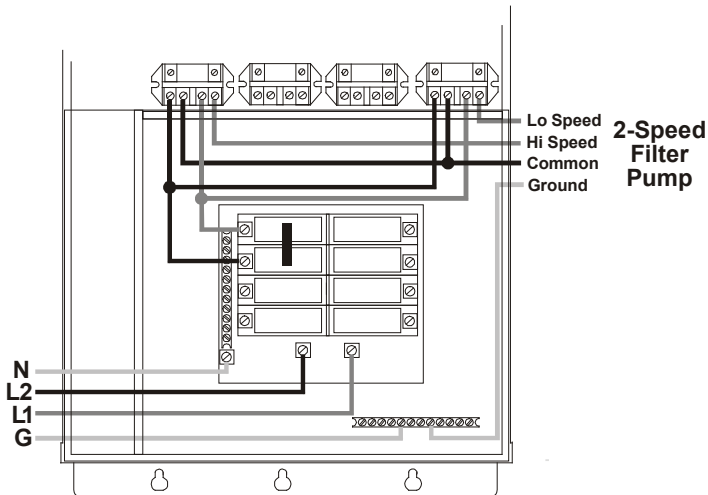

Lights: A ground fault circuit breaker must be used to supply power for high voltage pool/spa lighting. Low voltage lights will require an external transformer. For lighting systems that have both a light source and color wheel, connect the light source to the “Lights” relay and then connect the color wheel to one of the AUX outputs.



HAYWARD®

Hayward Variable Speed Pump: Proper installation of a Hayward Variable Speed Pump (VSP) includes high voltage input wiring, low voltage communication wiring, and menu configuration/settings. This Pool Control can operate one VSP. Refer to the diagram below for proper input wiring to the VSP. Wiring from the 220V breaker must NOT connect through the Filter relay.

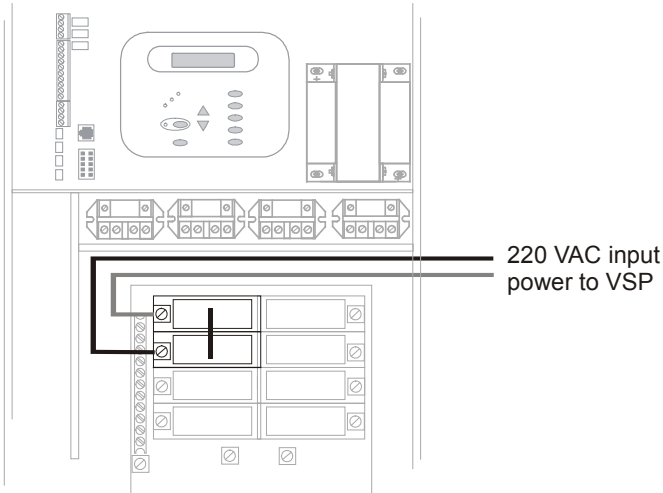

pH Dispense Output: *NOTE: The Pro Logic can only be used with a 120VAC pH dispensing device.* There are two Pro Logic versions that require different installation techniques. Pro Logics operating with a software version less than 4.00 require the pigtail or pH dispensing device to be connected to an internal relay. Units using version 4.00 or later have a dedicated pH output through the screw terminals mounted on the inside of the enclosure (shown on page 12). Refer to the AQL-CHEM's pH dispense wiring instructions that relates to your particular version.

Low Voltage Wiring

Valve Actuators

The Pro Logic can control up to three automatic valve actuators. Two of the valve outputs are dedicated to the pool/spa suction (Valve2) and return (Valve1) valves. Valve3 is for general purpose use (solar, water feature, in-floor cleaner, etc.).

For installations with solar heating, Hayward offers the AQ-SOL-KIT-xx solar kit that contains a valve, actuator, and extra temperature sensor. The "xx" indicates the valve type from the 2 choices below:

- 1P 1.5" Positive Seal
- 2P 2" Positive Seal

The Pro Logic is compatible with standard valve actuators manufactured by Hayward, Pentair/Com-pool, and Jandy. See diagram on page 12 for the location of valve connectors.

Heater Control

The Pro Logic provides a set of low voltage dry contacts that can be connected to most gas heaters or heat pumps with 24V control circuits. Refer to the diagram on page 16 for a generic connec-



HAYWARD®

tion. The manuals supplied with most heaters also include specific wiring instructions for connecting the heater to an external control (usually identified as “2-wire” remote control). For millivolt or line voltage heaters, contact Hayward Tech support, 908-355-7995. Refer to the diagrams and the information on the following pages for more details on the connection to several popular heaters.

Generic Heaters

1. Wire heater to 120/240V power source per the instructions in the heater manual. The Pro Logic does NOT control the power going to the heater.
2. Wire the Pro Logic dry contact heater output per the diagram below. Many internal parts of the heater can get very hot--see the heater manufacturer's recommendations on the minimum temperature rating for wires. If no guidance is given, use 105°C rated wire.
3. Set any ON/OFF switch on the heater to ON.
4. Set the thermostat(s) on the heater to the maximum (hottest) setting.

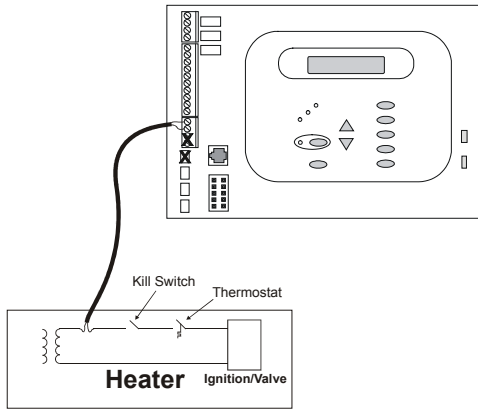

Laars Heaters

1. Turn power off to heater.
2. Remove factory jumper from terminal block.
3. Wire Pro Logic to the heater as shown.
4. Ensure toggle switch is in the ON position.
5. Set heater thermostats to maximum position.

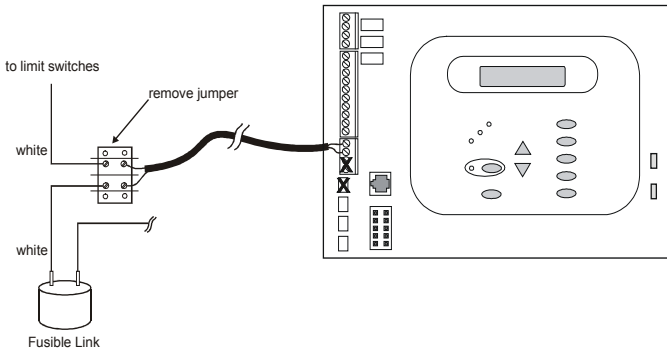



HAYWARD®

Hayward Heaters

Refer to the instructions in the heater manual for “2-wire Remote Thermostat” operation under “Remote Control Connections” and the diagram below:

1. Turn off power to heater.
2. Wire Pro Logic to terminals 1 & 2 (see diagram).
3. Leave jumper attached to terminals 4 & 5.
4. Move “BYPASS” dipswitch on heater circuit board to “ON” position (up).
5. Turn heater power back on.
6. Switch heater to either “Pool” or “Spa” (it doesn’t make any difference which is selected, the Pro Logic will take control).
7. Heater display should be “b0” (for “bypass On”).
8. Heater will fire whenever Pro Logic requests (when Pro Logic “Heater” LED is illuminated).

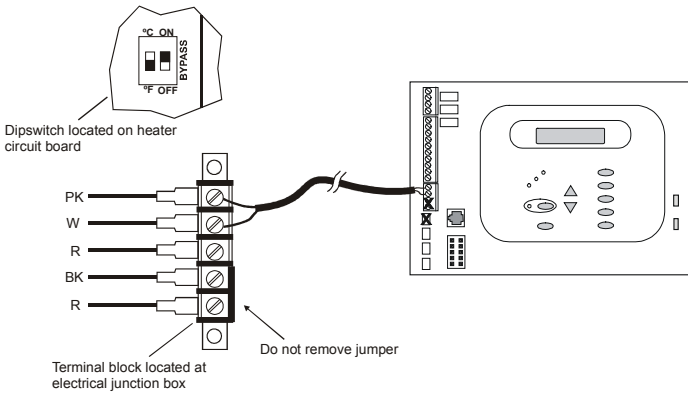

Pentair/Purex/MiniMax

1. Turn power off to heater.
2. Remove factory installed jumper from the “Ext Switch” connector.
3. Wire the Pro Logic to the “Ext Switch” connector as shown below.
4. The wires to the Pro Logic must be separated from any line voltage wires. Failure to follow these instructions may cause erratic operation of the heater.
5. Set the Power (Thermostat Select) switch to either “Pool” or “Spa”.
6. Set the “Pool” and “Spa” thermostats to their maximum settings.

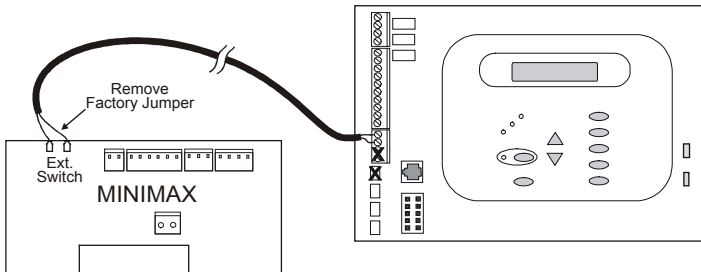



Raypak RP2100 Pool/Spa Heater

1. Turn power off to heater.
2. Push the mode button to "spa" mode.
3. Set the temperature to the maximum.
4. Push the mode button to "OFF".
5. Lastly, plug the prewired connector in the P7 position on the board.

IMPORTANT: The heater will display "OFF" when it is being remotely controlled by the Pro Logic. Some homeowners see the "OFF" display and, thinking this is a mistake, change the mode to "POOL" or "SPA" which then disables the remote control by the Pro Logic. To prevent this: Remove the heater touch pad connector (P5) which will disable the touchpad.

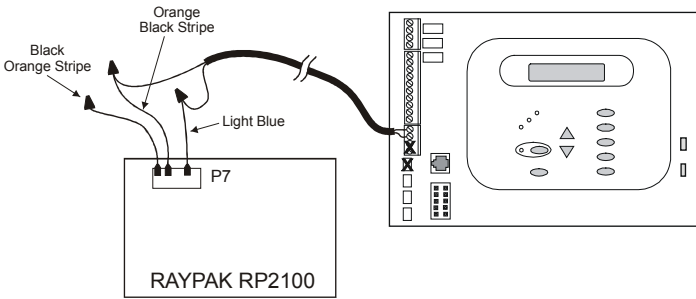

Drawing is for digital heater. If heater is a millivolt (analog), run red wires from Fireman's Switch to heater relay.

STA-RITE Heater

1. Turn power off to heater.
2. Remove upper jacket and open the control box.
3. Remove the jumper for the "fireman's switch".
4. Wire to the Pro Logic using wire rated for 105°C minimum.

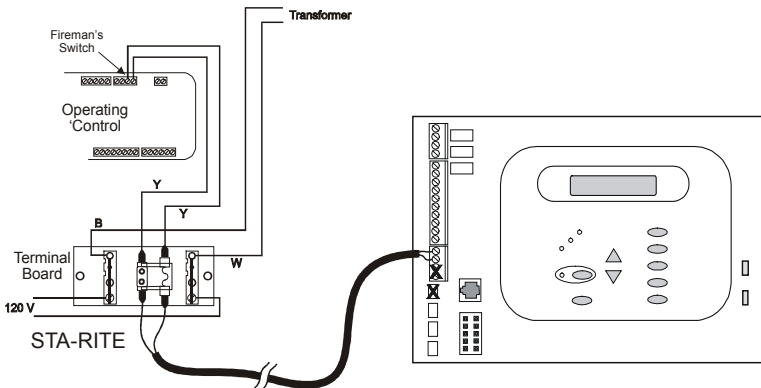



Hayward Variable Speed Pump (VSP) Wiring and Address Setting

Refer to your TriStar, TriStar VS or EcoStar manual(s) for proper low voltage communication wiring between the Pro Logic and the Hayward Variable Speed Pump.

A pump address must be configured if a VSP will be used. This address is entered into the VSP's configuration menu (TriStar and EcoStar) or set with dip switches (Tristar VS). Refer to the table to determine which address to use for your specific pump and Pro Logic. Select the proper address based on the model VSP you are configuring.

Pro Logic Output This is the output on the Pro Logic that is used to control the VSP.	VSP Address On the VSP, this is the name that should be selected under "Set COMM bus address" (EcoStar), "H.Comm ADDR." (TriStar) or set with dipswitches (Tristar VS).
FILTER	"001" - Tristar "Pool Filter" - EcoStar Refer to pump manual - Tristar VS

Temperature Sensors

The Pro Logic utilizes 10K ohm thermistor type sensors. Three sensors (water temperature, air temperature and solar temperature) are included. If the Pro Logic is being used to control a solar heating system, the solar sensor is required. The sensors are provided with a 15 ft. cable. See page 7 and the diagram below for installation information.

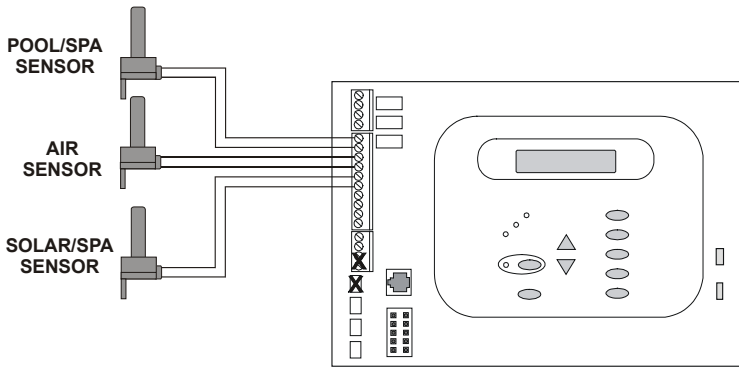



HAYWARD®

Remote Display/Keypad

The Pro Logic main unit can connect to a maximum of 3 remote wired display/keypads (ordered separately).

Use four conductor cable (typically phone cable) to connect the wired remote display/keypad with the Pro Logic Control Center as shown below. The maximum wiring distance is 500ft. (160m). Note that the terminals on both the Pro Logic main unit and the wired remote display/keypad are numbered: Connect 1 to 1, 2 to 2, etc. Refer to diagram below.

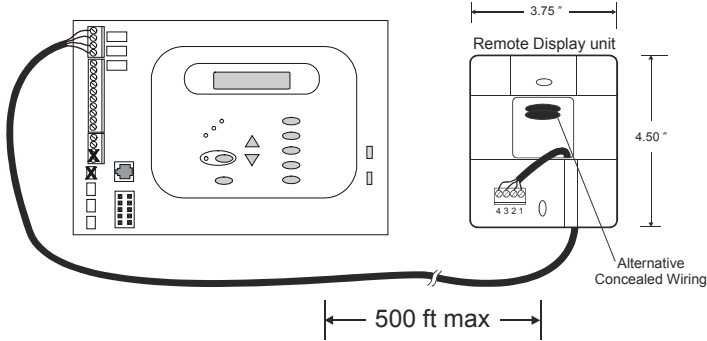

If multiple remote display/keypads are installed: Never connect more than 2 wires to any terminal block. Two remotes can be wired back to the Pro Logic main unit or the second display/keypad (and third, if applicable) can be “daisy chained” with one display/keypad wired to the next. The maximum wire run from the Pro Logic main unit to the furthest remote display/keypad is 500 ft (160m).

Base Station

Plug in the pigtail connector from the wireless base station into the “wireless” connector on the main PCB in the Pro Logic control unit.

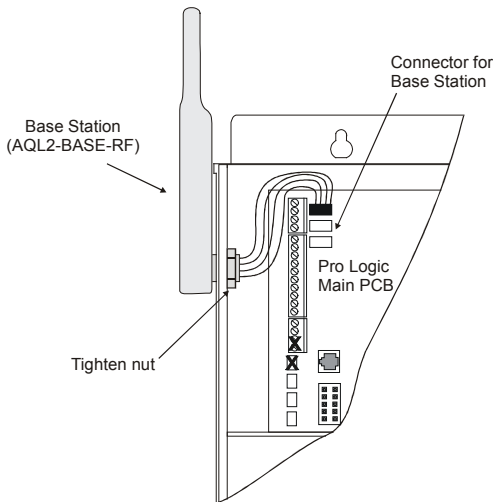



HAYWARD®

AQL-CHEM ORP and pH Sensing Kit

Plug in the connector from the AQL-CHEM into one of the "COMM" connectors on the main PCB in the Pro Logic control unit as shown below.

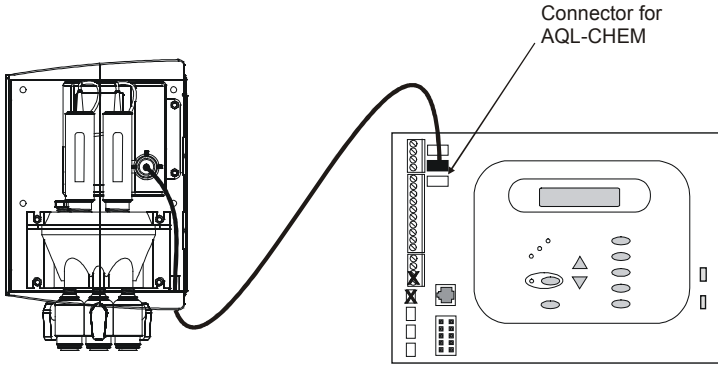

Flow Switch

Only applicable if the chlorinator function is enabled. The flow switch cable plugs into the Pro Logic Control Center at the location shown in the diagram on page 12. Ensure that the connector catch "snaps" in order to provide a reliable connection.

Turbo Cell

Only applicable if the chlorinator function is enabled. The Turbo Cell should be plugged in after the Pro Logic cover panel is put back in place. Refer to page 12 for the location of the connector.

External Input Interlock

The External Input Interlock provides a means to force the filter pump or an Aux output off when certain conditions exist. A normally open or normally closed on/off external device must be connected to the Pro Logic as shown below. After properly configuring the Pro Logic (see Configuration), the filter pump and/or desired Aux will be forced off when the device is active.

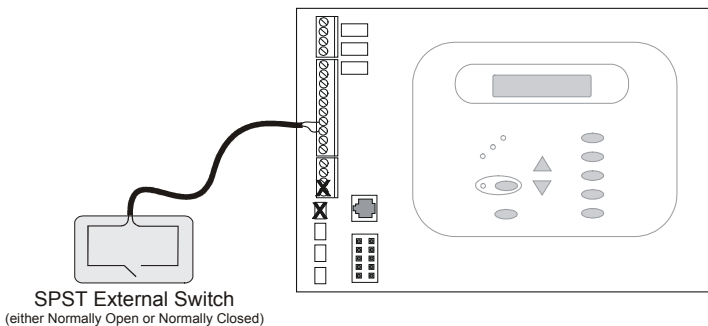



HAYWARD®

Hayward Aqua Rite Chlorinator

The Pro Logic can control one or more Hayward Aqua Rite chlorinators when additional sanitizing capacity is required. A 4 wire connection is used to communicate to the Aqua Rite and can be wired up to 500' apart. Any outdoor rated 4 conductor cable can be used. Refer to the wiring diagrams below for proper wiring connection to the Aqua Rite. *NOTE: There must be only 1 "primary" unit. All other Aqua Rite units must be configured as "secondary".*

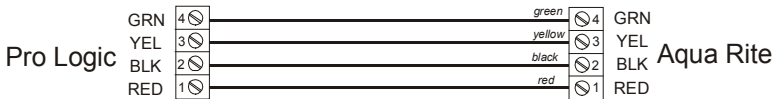
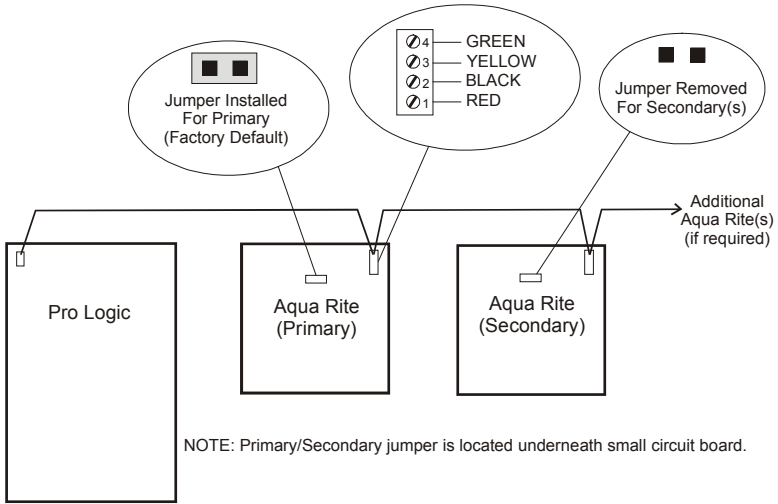





Configuration

After plumbing and wiring are complete, the Pro Logic MUST BE CONFIGURED before attempting to operate. Configuration information is entered at the keypad and “tells” the Pro Logic what equipment is connected and how each should be controlled.

Accessing the Configuration Menus

Configuring the Pro Logic requires that you navigate through the Configuration Menu and input various information. For more detailed information about using the Pro Logic menu system, refer to the Operation Manual.

To access the Configuration Menu:









Configuration Menu-Locked  Press repeatedly until “Configuration Menu” is displayed
 Press BOTH buttons SIMULTANEOUSLY for 5 seconds to unlock

Configuration Menu-Unlocked  Move to configuration menu items

NOTE: The configuration menu automatically “locks” after 2 minutes of no buttons being pressed to prevent unauthorized people from changing the control logic inadvertently and possibly damaging the pool equipment or causing a “call back” to fix the configuration.

Configuration Menu Items

Each item needs to be programmed and may contain additional sub-menu items. Refer to the following pages for information on programming.

- Chlor. Config.**  Push to access Chlorinator option
 + to view/change  Move to next configuration menu
- Chlorinator Enabled**  Toggle between Chlorinator Enabled and Disabled (default)
 Move to next menu item
- Display Salt**  Toggle between Display Salt (default) and Minerals
 Move to previous/next configuration menu
- Cell Type T-CELL-15**  Rotates between available Cell types
 Move to next menu item

Chlorinator

Requires the use of a chlorinator cell and P-KIT sold separately. If the chlorinator is enabled, then the cell and flow switch must also be installed and the Pro Logic will automatically chlorinate both the pool and spa according to the desired output setting (see Settings Menu in the Operation manual). If disabled (default), all displays relating to the chlorinator will be suppressed. When the chlorinator is enabled, the Pro Logic will automatically detect and control any Aqua Rite(s) installed in the system.

Display

Allows for the display of salt (default) or mineral values.

Cell Type Selection

The Cell Type Menu appears after “Display Salt/Minerals” in the Chlorinator Configuration Menu. The options are T-CELL-15 (default), T-CELL-9, T-CELL-5 or T-CELL-3. Make the proper selection based on the chlorinator cell that is used in your system. The available selections are listed:



HAYWARD®

"T-CELL-3" = T-CELL-3, GLX-CELL-3-W
 "T-CELL-5" = GLX-CELL-5, GLX-CELL-5-W
 "T-CELL-9" = T-CELL-9, GLX-CELL-9-W
 "T-CELL-15" = T-CELL-15, GLX-CELL-15-W

Chemistry Config. Wizard + to enter **+** Press to access Chemistry Config. Wizard
<> Move to previous/next menu item

Chemistry Configuration Wizard

Requires use of the optional AQL-CHEM Sensing Kit. Following the steps of the Chemistry Config. Wizard will set up the AQL-CHEM to sense ORP and pH levels and, if chlorination is used, can configure the Pro Logic to generate the correct amount of chlorine to properly sanitize the pool. Refer to the AQL-CHEM manual for more detailed information.

- Pool/Spa Config. + Push to access Pool/Spa options
+ to view/change **<>** Move to previous/next configuration menu
- Pool/Spa Setup + Rotates between Pool Only (default), Spa Only and
Pool and Spa **<>** Move to next menu item
- if "Pool and Spa" is selected*
Spa - CountDn + Adjust time setting (Manual On/Off, 0:05, 0:10, 0:15..., (default is 4:00))
00:30 **<>** Move to next menu item
- if "Pool and Spa" is selected*
Spa Spillover + Toggle between Enabled and Disabled (default) Spa Spillover
Enabled **<>** Move to next menu item or previous/next configuration menu
- if "Pool and Spa" is selected and
if "Spa Spillover" is enabled*
Filter Operation + Toggle between Pool Only (default) and Spa Spillover options
Spa Spillover **<>** Move to previous/next configuration menu
- if "Pool Only" or "Spa Only" is selected*
V1=Aux1, V2=Aux2 + Toggle between Enabled and Disabled (default)
Disabled **<>** Move to previous/next configuration menu
- if "Pool and Spa" is selected*
Filter Off Valve + Toggle between Enabled (default) and Disabled
Change: Enabled **<>** Move to previous/next configuration menu

Pool/Spa Setup

If "Pool Only" or "Spa Only" are selected, then the pool/spa valves are not needed and pushing the POOL/SPA button on the display/keypad will have no effect. If "Pool and Spa" is selected, then the pool/spa suction and return valve actuators should be connected to the Pro Logic. Pressing the POOL/SPA button on the display/keypad will allow the homeowner to alternate between pool and spa operation.

Spa CountDn

This menu will appear only if Pool/Spa Setup is set to "Pool and Spa". This setting is the time, after you manually switch the Pool/Spa valves to "Spa Only", until the Pro Logic automatically returns the valves to their previous positions. It is programmed in increments of 5 minutes, from "Manual On/Off" (0 minutes) to "21:00" (21 hours). The filter is forced on during this time period.

Spa Spillover

When spa spillover is "Enabled" and the Pool/Spa Setup is set to "Pool and Spa", the homeowner will be able to rotate through "Pool Only" (both suction and return valves switched to pool), "Spa Only" (both suction and return valves switched to spa) and "Spillover" (suction valve switched to pool and return valve switched to spa) by successive presses of the "Pool/Spa" button.



Filter Operation

If "Spa Spillover" is selected, the Pro Logic will automatically switch the pool/spa suction and return valves to "spillover" at the start of the programmed pool filtering time period or when the super chlorinate function is turned on. The valves will remain in this position for the remainder of the super chlorinate period. This option is usually preferable because both the pool and spa water will be filtered and sanitized.

If "Pool Only" is selected, then the Pro Logic will switch the pool/spa valves to the "pool only" position at the start of the programmed pool filtering time period or when the super chlorinate function is turned on. This may be desirable on some systems with in-floor cleaners because it allows the cleaner to operate all the time the pool is being filtered and/or the super chlorinate is running.

V1=Aux1, V2=Aux2

This menu appears only if the Pool/Spa Setup is "Pool Only" or "Spa Only". When enabled, Valve 1 (return) will follow the Aux1 output and Valve 2 (suction) will follow the Aux2 output. When disabled (default), the return and suction pool/spa valves function normally.

Filter Off Valve Change

This menu appears only if Pool/Spa setup is set to "Pool and Spa - Std". When enabled (default), the filter pump will shut off for 35 seconds whenever the Pool/Spa valves are turning. The pump will NOT shut off when a heater is in Heater Cooldown mode.

Filter Config. + to view/change	+ Push to access pump options <> Move to previous/next configuration menu
Filter Pump 1 Speed	+- Rotates between 1-speed (default), 2-speed and variable speed options <> Move to next menu item
<i>if "Variable Speed" is selected</i>	
Lowest Speed 10%	+- Adjust the lowest speed desired for variable speed operation <> Move to next menu item
<i>if "Variable Speed" is selected</i>	
Highest Speed 100%	+- Adjust the highest speed desired for variable speed operation <> Move to next menu item
Freeze Protect Enabled	+- Toggle between Enabled (default) and Disabled Freeze Protection <> Move to next menu item or previous/next configuration menu
<i>if "Freeze Protect" is enabled and "2-speed Filter" is selected</i>	
Freeze Protect High Speed	+- Toggle between high speed (default) and low speed <> Move to next menu item
<i>if "Freeze Protect" is enabled and "Variable Speed" is selected</i>	
Freeze Protect Speed 50%	+- Select the desired Freeze Protection speed from Filter Lowest to Filter Highest speed <> Move to next menu item
<i>if "Freeze Protect" is enabled</i>	
Freeze Temp 38°F	+- Adjust the desired freeze protection temperature (33°F - 42°F) <> Move to next menu item
External Input Disabled	+- Toggle between Enabled and Disabled (default) <> Move to previous/next configuration menu

Filter Pump

2-speed pumps: When a 2-speed pump is configured, one of the AUX relays must also be configured to control the low speed motor winding on the pump. Refer to the appropriate sections in the Installation manual for specific information regarding the control logic for 2-speed and variable speed pump operation.



HAYWARD®

Variable Speed pump: The pump is always connected to power and communication between the Pro Logic and the pump will determine the pump's operational state. When the filter output is on, the pump will run. When the filter pump output is off, the pump will be off. On, off and speed are controlled by commands sent to the pump.

Lowest Speed

This is the lowest speed that the variable speed pump is allowed to run at. It is used as the lower limit in the Low Speed Settings Menu. Set lowest speed from 10% (default) to 50%.

Highest Speed

This is the highest speed that the variable speed pump is allowed to run at. It is used as the upper limit in the High Speed Settings Menu. Also, this is the speed that the pump will run at during the first 3 minutes of operation anytime the pump has been off for more than 30 seconds. Set highest speed from 20% to 100% (default).

Freeze Protection

Freeze protection is used to protect the pool and plumbed equipment against freeze damage. If freeze protection is enabled and the AIR temperature falls below the freeze threshold (see below), the Pro Logic will turn on the filter pump to circulate the water. If "Pool and Spa" is selected in the Pool/Spa sub-menu, the valves will also alternate between the pool and spa every 30 minutes and the filter pump will turn off while the valves are turning. The chlorinator will not operate if freeze protection is the only reason the pump is running.

Freeze Protection Speed

This menu only appears if freeze protection is enabled and the pump is configured for 2-speed or variable speed pump operation. If the pump turns on due to freeze protection only, the pump will run at this speed.

2-Speed pumps: Select high (default) or low speed operation.

Variable Speed pump: Select the desired speed (from Filter Lowest to Filter Highest speed).

Freeze Protection Temperature

Select the temperature to be used for freeze protection. Temperature is adjustable from 33°F-42°F (1°C-6°C). 38°F (3°C) is default. This threshold will be used for all outputs that have freeze protection enabled.

External Input Interlock

When enabled, the filter pump will be forced off when the external input is active. Note that freeze protection will have precedence over this feature.



- | | |
|-------------------------------------|--|
| Heater1 Config.
+ to view/change | + Push to access heater options
<> Move to previous/next configuration menu |
|-------------------------------------|--|

- | | |
|--------------------|--|
| Heater1
Disable | +- Toggle between Enabled and Disabled (default) Heater 1
<> Move to next menu item or previous/next configuration menu |
|--------------------|--|
- | | |
|--------------------------------|---|
| <i>if "Heater1" is enabled</i> | |
| Heater1 Cooldown
Disabled | +- Toggle between Enabled and Disabled (default) Heater 1 Cooldown
<> Move to next menu item |
- | | |
|--------------------------------|---|
| <i>if "Heater1" is enabled</i> | |
| Heater1 Extend
Disabled | +- Toggle between Enabled and Disabled (default) Heater 1 Extend
<> Move to previous/next configuration menu |
- | | |
|--|---|
| <i>if "Heater1" is enabled and 2-speed filter pump is selected</i> | |
| Allow Low Speed
Disabled | +- Toggle between Enabled and Disabled (default)
<> Move to next menu item or previous/next configuration menu |
- | | |
|---|--|
| <i>if "Heater1" is enabled and variable speed filter pump is selected</i> | |
| Minimum Speed
50% | +- Select the desired minimum filter pump speed for Heater 1 (Filter Lowest to Highest)
<> Move to next menu item or previous/next configuration menu |

Heater1

If the heater is "Enabled", the heater relay will turn on when the water temperature is less than the desired temperature setting and the filter pump is running. The desired temperature is in the "Settings Menu". If applicable, the homeowner will be prompted to enter separate "pool" and "spa" settings. Depending on the position of the pool/spa suction valves, the proper temperature setting will be used.

Heater Cooldown

This feature ensures that the heater cools down before water circulation is stopped. When enabled, the Pro Logic will continue to run the filter pump for 5 minutes after the heater turns off. During this period the filter pump LED will flash and also a "Heater Cooldown, X:XX remaining" message will scroll on the display.

When the filter pump is running and the heater is on: Pressing the "Filter" button once will cause the heater to turn off, but the filter pump will continue to run for heater cooldown (filter LED flashing and message on display). Pushing the filter button a second time will override the heater cooldown operation and turn the filter pump off.

Heater Extend

If "Enabled", the filter extend logic keeps the filter pump running beyond the normal turn-off time until the pool (or spa) is heated up to the desired temperature setting (see Settings Menu). Heater extend will NOT cause the filter pump to turn on, it will only delay the turn off time when the heater is operating.

Allow Low Speed

This menu only appears if the filter is configured for 2-speed operation. During default operation, high speed mode is used whenever the heater is on. If Allow Low Speed is enabled, low speed will be allowed even if the heater is on.

Minimum Speed

This menu only appears if the filter is configured for variable speed operation. This is the minimum speed the pump will run at when the heater is on. The selection is from Filter Lowest to Filter Highest speed.



HAYWARD®

- Solar Config. + Push to access solar options
+ to view/change <> Move to previous/next configuration menu
- Solar +-- Toggle between Enabled and Disabled (default) Solar
Disabled <> Move to next menu item or previous/next configuration menu
- if "Solar" is enabled*
Solar-Extend +-- Toggle between Enabled and Disabled (default) Solar Extend
Disabled <> Move to next menu item
- if "Solar" is enabled*
Solar Priority +-- Toggle between Enabled and Disabled (default) Solar Priority
Disabled <> Move to next menu item
- if "Solar" is enabled and
"2-speed Filter" is selected*
Allow Low Speed +-- Toggle between Enabled and Disabled (default)
Disabled <> Move to next menu item or previous/next configuration menu

Solar

If the solar control logic is "Enabled", several additional steps must be taken to ensure proper operation of the solar system. If the solar is operated by a valve, then the Valve3 output must be set up for solar logic. If the solar is operated by a pump, then one of the AUX relays must be set up for solar logic. Also, the "solar" temperature sensor must be installed. This sensor is typically mounted near the collector array and is used to sense whether sufficient solar heat is available.

If solar is "Enabled", the valve or solar pump relay will turn on when the water temperature is less than the desired temperature setting AND the solar temperature is hotter than the water. The desired temperature is in the "Settings Menu". If applicable, the homeowner will be prompted to enter separate pool and spa desired temperature settings. Depending on the position of the pool/spa suction valve, the proper temperature setting will be used.

Solar Extend

If "Enabled", the filter extend logic keeps the filter pump running beyond the normal turn-off time if solar heat is still available. When solar heat is no longer available, both the solar valve/pump and filter pump will turn off simultaneously. Solar extend will NOT cause the filter pump to turn on, it will only delay the turn off time when solar is operating.

Solar Priority

If both "Solar Control" and "Heater Control" are enabled, the Solar Priority feature will keep the conventional heater off whenever solar heat is available. This provides the most cost effective way of heating the pool. When solar heat is not available, the conventional heater will operate normally.

Allow Low Speed

This menu only appears if the pool filter is configured for 2-speed operation. During default operation, high speed mode is used whenever the solar heater is on. If Allow Low Speed is enabled, low speed pump operation will be allowed during solar heating except for the first 3 minutes after solar heat turns on.

- External Input +-- Toggle between Open and Closed (default)
Active Closed <> Move to next menu item or previous/next configuration menu

External Input

The external input device can either be normally open or normally closed. In this menu, select the state of the external input device when active.



- | | | |
|---|----------|---|
| Lights Config.
+ to view/change | +
<> | Push to access Lights options
Move to previous/next configuration menu |
| Lights Name
Pool Light | +-
<> | Rotates between all available names
Move to next menu item or previous/next configuration menu |
| Lights Function
Manual On/Off | +-
<> | Rotates between Manual On/Off (default), Countdown Timer, Low Speed- Filter, Timeclock, Solar, and Super Chlorinate
Move to next menu item |
| <i>for manual on/off, countdown timer and timeclock functions</i> | | |
| Lights Relay
Standard | +-
<> | Toggle between Standard (default) and Dimmer
Move to next menu item or previous/next configuration menu |
| <i>for all functions except solar, dimmer relay, super chlorinate and low speed</i> | | |
| Lights Interlock
Disable | +-
<> | Toggle between Enabled and Disabled (default) Lights Interlock
Move to next menu item |
| <i>for all functions except solar, dimmer relay, super chlorinate pH dispense, low speed, and group</i> | | |
| Lights Ext Input
Disabled | +-
<> | Toggle between Enabled and Disabled (default)
Move to previous/next configuration menu |
| <i>for all functions except dimmer relay, super chlorinate pH dispense, low speed, and group</i> | | |
| Lights Freeze
Disable | +-
<> | Toggle between Enabled and Disabled (default) Lights Freeze
Move to previous/next configuration menu |
| <i>if filter pump is set to variable speed and the relay type is set to standard</i> | | |
| Lights Pump Spd
Settings Menu | +-
<> | Select Settings Menu (default) or desired pump speed (Filter Lowest to Highest)
Move to previous/next configuration menu |

Lights Function

Although designated as the “Lights” output, the function of the lights relay is similar to the aux1 and aux2 relays. If pool lights are wired to the lights relay, some options including Solar function, Low Speed of a 2-Speed Filter Pump, Lights Interlock and Lights Freeze Protection will not be necessary and should be disabled. If no pool lights are used, the lights relay can be used to control other pool devices that may require these options. The function of each option is shown below.

Manual On/Off (default) – the lights relay will alternate between turning on and off when the LIGHTS button is pressed. There is no automatic control logic.

Countdown Timer – the lights relay will turn on when the LIGHTS button is pressed. The lights relay will turn off automatically after a programmed time (see Timers Menu in Operation Manual). The LIGHTS button can also be used to turn the output off.

Low Speed of a 2-speed Filter Pump – the Pro Logic will turn on the lights relay whenever the low speed operation of the filter pump is required. It is very important that the “2-speed” filter pump option be selected under the “Filter Config.” Menu for proper operation.

Timeclock – the lights relay will turn on and turn off at the times set for the lights timeclock in the Timers Menu (see Timers Menu in Operation Manual). The LIGHTS button can also be used to turn the output on and off.

Solar – the lights relay can operate a solar booster pump which will turn on when the filter pump is running and solar heat is available and the water is less than the desired temperature setting. It is important to note that “Solar Control” must be enabled in the “Solar Config.” menu for proper operation to occur.



HAYWARD®

Super Chlorinate – if “Chlorinator” is enabled, this option allows the user to start a Super Chlorinate cycle when the Lights button is pressed, rather than using the Settings Menu. Note that only one button can be assigned to this function.

Lights Relay

This feature allows the user to select either “Standard” (default) or “Dimmer” for the Lights output. The optional AQL-DIM dimmer kit must be installed if “Dimmer” is desired.

When “Dimmer” is selected, and the Lights output is manually turned on, the “+” and “-” buttons adjust the level from 20% to 100% (default). The level is saved for the next time the lights are turned on.

Lights Interlock

If enabled, this feature will override the function (Manual On/Off, Countdown Timer, Timeclock) selected above and turn the lights relay off when: filter pump is off, first 3 minutes of filter pump operation (allows the pump to prime and get water flowing), when the pool/spa suction return valves are in any position other than “pool only”, or for the first 3 minutes after solar turns on (allows air in the solar panels to be purged). Interlock is not available for solar, low speed filter pump, super chlorinate or dimmer.

Lights External Input Interlock

When Lights External Input Interlock is enabled, the lights output will be forced off when the external input is active. This will have precedence over freeze protection. Lights External Input Interlock is not available for solar, low speed filter pump, dimmer, super chlorinate, or pH dispense functions.

Lights Freeze Protection

This function helps protect equipment that is wired to the lights relay against freeze damage. If Freeze Protection is enabled and the AIR temperature falls below the selected freeze temperature threshold, the Pro Logic will energize the lights relay. **IMPORTANT:** this only enables operation of the lights relay during freeze--see the “Filter Pump Config.” menu to enable freeze protection for the main circulation system.

Lights Pump Speed

This is the speed of the filter pump when the Lights output is on. This is the speed of the pump that has been selected in the Settings Menu for normal filter operation. If an alternate speed is desired when the Lights output is on, push “+” or “-” and select from “Filter Lowest” to “Filter Highest” in 5% increments.



HAYWARD®

Aux1 Config.
+ to view/change

- + Push to access Aux options
- <> Move to previous/next configuration menu

Aux1 Function
Manual On/Off

- + Rotates between Manual On/Off (default), Countdown Timer, Low Speed- Filter, Timeclock, Solar, and Super Chlorinate
- <> Move to next menu item

for manual on/off, countdown timer and timeclock functions

Aux1 Relay
Standard

- + - Toggle between Standard (default), and Dimmer
- <> Move to next menu item or previous/next configuration menu

for all functions except solar, dimmer relay, super chlorinate and low speed

Aux1 Interlock
Disable

- + - Toggle between Enabled and Disabled (default) Aux1 Interlock
- <> Move to next menu item

for all functions except solar, dimmer relay, super chlorinate and low speed

Aux1 Ext Input
Disabled

- + - Toggle between Enabled and Disabled (default)
- <> Move to previous/next configuration menu

for all functions except dimmer relay, super chlorinate and low speed

Aux1 Freeze
Disable

- + - Toggle between Enabled (default) and Disabled Aux1 Freeze
- <> Move to previous/next configuration menu

if filter pump is set to variable speed and the relay type is set to standard

Aux1 Pump Spd
Settings Menu

- + - Select Settings Menu (default) or desired pump speed (Filter Lowest to Highest)
- <> Move to previous/next configuration menu

NOTE: The configuration parameters for the Aux2 output are the same as shown below for Aux1.

WARNING: Do not use the Pro Logic to control an automatic pool cover. Swimmers may become entrapped underneath the cover.

Aux1 Function

Manual On/Off (default) – the aux relay will alternate between turning on and off when the aux button is pressed. There is no automatic control logic.

Countdown Timer – the aux relay will turn on when the AUX button is pressed and then will turn off automatically after a programmed time (see Timers Menu, Operation Manual). The AUX button can also be used to turn the output off.

Low Speed of a 2-speed Filter Pump – the Pro Logic will operate the aux relay whenever the low speed operation of the filter pump is required. It is very important that the “2-speed” filter pump option be selected under the “Filter Config.” Menu for proper operation.

Timeclock – the aux relay will turn-on and turn-off at the times set for the aux1 timeclock in the Timers Menu. The AUX button can also be used to turn the output on and off.

Solar – the aux relay operates a solar booster pump which will turn on when the filter pump is running and solar heat is available and the water is less than the desired temperature setting. It is important to note that “Solar Control” must be enabled in the “Solar Config.” menu for proper operation to occur.

Super Chlorinate – if “Chlorinator” is enabled, this option allows the user to start a Super Chlorinate cycle when the Aux button is pressed, rather than using the Settings Menu. Note that only one button can be assigned to this function.



HAYWARD®

Aux1 Relay

This feature allows the user to select either “Standard” (default) or “Dimmer” for the Aux1 output. The optional AQL-DIM dimmer kit must be installed if “Dimmer” is desired.

When “Dimmer” is selected, and the Aux1 output is manually turned on, the “+” and “-” buttons adjust the level from 20% to 100% (default). The level is saved for the next time the aux1 output is turned from off to on.

Aux1 Interlock

If “Enabled”, this feature will override the function (Manual On/Off, Countdown Timer, Timeclock), selected above and turn the aux1 off when: filter pump is off, first 3 minutes of filter pump operation (allows the pump to prime and get water flowing), when the pool/spa suction return valves are in any position other than “pool only”, or for the first 3 minutes after solar turns on (allows air in the solar panels to be purged). Interlock is not available for solar, low speed filter pump, super chlorinate or dimmer.

Aux1 External Input Interlock

When Aux1 External Input Interlock is enabled, the Aux1 output will be forced off when the external input is active. This will have precedence over freeze protection. Aux1 External Input Interlock is not available for solar, low speed filter pump, dimmer, group, super chlorinate, or pH dispense functions.

Aux1 Freeze Protection

This function protects the pool, plumbing, and equipment against freeze damage. If Freeze Protection is enabled and the AIR temperature falls below the selected freeze protection temperature, the Pro Logic will turn on the aux relay to circulate the water.

IMPORTANT: this only enables operation of the AUX output during freeze--see the “Filter Pump Config.” menu to enable freeze protection for the main circulation system. Freeze Protection is not available for low speed filter pump, dimmer, group, super chlorinate or pH dispense functions.

Aux1 Pump Speed

This is the speed of the filter pump when the Aux1 output is on. This is the speed of the pump that has been selected in the Settings Menu for normal filter operation. If an alternate speed is desired when the Aux1 output is on, push “+” or “-” and select from “Lowest” to “Highest” in 5% increments.



Valve3 Config. + to view/change	+ Push to access Valve3 options <> Move to previous/next configuration menu
Valve3 Function Solar	+↔ Rotates Timeclock (default), Solar, In-floor Cleaner and Super Chlorinate <> Move to next menu item
<i>for all functions except solar and super chlorinate</i>	
Valve3 Interlock Disabled	+↔ Toggle between Enabled and Disabled (default) Valve3 Interlock <> Move to next menu item
<i>for all functions except solar and super chlorinate</i>	
Valve3 Ext. Input Disabled	+↔ Toggle between Enabled and Disabled (default) <> Move to previous/next configuration menu
<i>for all functions except super chlorinate</i>	
Valve3 Freeze Disabled	+↔ Toggle between Enabled and Disabled (default) Valve3 Freeze <> Move to previous/next configuration menu
<i>if filter pump is set to variable speed and the relay type is set to standard</i>	
Valve3 Pump Spd Settings Menu	+↔ Select Settings Menu (default) or desired pump speed (Filter Lowest to Highest) <> Move to previous/next configuration menu

Valve3 Function

Timeclock (default) – the valve turns on/off at the times set for the valve3 timeclock in the Timers Menu (see Operations Manual). The VALVE3 button can also be used to turn the valve output on or off.

Solar – the valve operates when the filter pump is running and solar heat is available and the water temperature is less than the desired temperature setting. Solar heating must be enabled in the “Solar Config.” menu for proper operation to occur.

In-Floor Cleaner – the valve switches the water returning to the pool between the in-floor cleaner and the normal return jets which facilitates efficient surface skimming. The valve will operate the in-floor cleaner for the first half of each clock hour and then switch to the jets/skimming for the last half of the hour.

Super Chlorinate – if “Chlorinator” is enabled, this option allows the user to start a Super Chlorinate cycle when the Valve3 button is pressed, rather than using the Settings Menu. Note that only one button can be assigned to this function.

Valve3 Interlock

If “Enabled”, this feature will override the function (timeclock or in-floor cleaner) selected above and turn the valve off when: the filter pump is off, first 3 minutes of filter pump operation (allows the pump to prime and get water flowing), or for the first 3 minutes after solar turns on (allows air in the solar panels to be purged). Interlock is not available for solar or super chlorinate.

Valve3 External Input Interlock

When Valve3 External Input Interlock is enabled, the Valve3 output will be forced off when the external input is active. This will have precedence over freeze protection. Valve3 External Input Interlock is not available for solar and super chlorinate.

Valve3 Freeze Protection

This function protects the pool and plumbed equipment against freeze damage. If Freeze Protection is enabled and the AIR temperature falls below the selected freeze temperature threshold, the Pro Logic will turn on the valve to allow circulation of the water. **IMPORTANT:** this only enables operation of the valve3 output during freeze – see the “Filter Pump Config.” menu to enable freeze protection for the main circulation system.



Valve3 Pump Speed

This is the speed of the pump when the Valve3 output is on. This is the speed of the pump that has been selected in the Settings Menu for normal filter operation. If an alternate speed is desired when the Valve3 output is on, push "+" or "-" and select from "Filter Lowest" to "Filter Highest" in 5% increments.

if AQL-SS-6B is connected

6B Spa Config.
+ to view/change + Push to access the 6 Button Spa Side Remote options
◀> Move to previous/next configuration menu

Select 6B Spa
A +- Rotates between all available remotes
◀> Move to next menu item

6B A, Button 1
Pool/Spa +- Rotates between System Off, Pool/Spa, Filter, Lights, Heater1, Aux1 and Aux2
◀> Move to previous/next menu item or next configuration menu

Select 6B Spa

This menu only appears if more than one AQL-SS-6B is detected at power up. Select which of the available remote controls (A, B or C) is to be configured.

6B A, Button 1

This menu allows the user to map each button of the AQL-SS-6B to one of the standard Pro Logic functions. The default selections are: Button 1 - Pool/Spa, Button 2 - Filter, Button 3 - Lights, Button 4 - Heater1, Button 5 - Aux1 and Button 6 - Aux2.

Remote Menus
Enabled +- Toggle between Enabled (default) and Disabled Remote Menus
◀> Move to previous/next configuration menu

This feature will prevent unauthorized access to the Settings, Timers, and Configuration menus from any of the Pro Logic's remote display/keypads. When disabled, the remote display/keypads will only show the default menu and allow on/off control via the push-buttons. Note that the function of the Pro Logic's built-in display/keypad is unchanged by this selection. Once disabled, the only way to enable "Remote Menu" is to use the local display/keypad.

All Timeclocks
7-day +- Toggle between 7-day (default) and Weekend/Weekday time options
◀> Move to previous/next configuration menu

This selection affects ALL of the timeclock logic in the Pro Logic. If "7-day" is selected, each timeclock will have one set of turn-on/turn-off settings that operate every day of the week. If "Weekend/Weekdays" option is selected then the user can enter one set of turn-on/turn-off times for the weekend (fixed as Saturday/Sunday) and another set of turn-on/turn-off times for weekdays (Monday through Friday).

Time Format
12 hour AM/PM +- Toggle between 12 hour AM/PM (default) and 24 hour time format options
◀> Move to previous/next configuration menu

Units
°F and PPM +- Toggle between °F and PPM (default) and °C and g/L (Metric) options
◀> Move to previous/next configuration menu

if any output is configured as a variable speed pump

VSP Speed
% +- Toggle between % and RPM
◀> Move to previous/next configuration menu

This is the unit of measure for displaying the speed of the variable speed pump. Select % of maximum speed (3450 RPM) or revolutions per minute (RPM).



HAYWARD®

Reset Config. to
Default Press +

- + Initiate reset of all configuration parameters
- <> Move to previous/next configuration menu (config. not reset)

Are you sure?
+ to proceed

- + Reset all configuration parameters
- <> Move to previous/next menu (config. not reset)

Config. reset
Confirmed

- <> Move to previous/next configuration menu

Use this function to erase all previous system configuration and reset all configuration parameters back to the factory default values. This function is NOT reversible--be careful.

Maintenance Menu (only displays if Sensing System is enabled)

The Maintenance Menu will be displayed only if the optional AQL-CHEM is used and the Sensing System is enabled in the Chemistry Config. Wizard. This menu is used to perform functions relating to the AQL-CHEM ORP and pH sensing kit.

pH Calibration
Wizard, + to enter

- + Push to access pH Calibration Wizard
- <> Move to previous/next menu item

Use this Wizard to calibrate the AQL-CHEM's pH probe. This requires a manual pH test of the pool water using a dependable red phenol test kit.

Clean Probe Wizard
+ to enter

- + Push to access Clean Probe Wizard
- <> Move to previous/next menu item

Use this Wizard to clean the AQL-CHEM's ORP and pH probes. The probes must be clean and free from oil, chemical deposits and contamination to function properly. Slow response, increased need to calibrate, and inconsistent readings are indications that the probes need to be cleaned.



HAYWARD®

System Startup and Checkout

Before Startup

Before starting the Pro Logic for the first time, be sure that the following items have been completed:

1. Pool/spa chemicals are within the recommended levels according to the chart on page 4.
2. Pool/spa salt level is between 2700-3400 PPM.
3. Properly rated circuit breakers are installed in the Pro Logic subpanel.
4. All wiring is performed according to NEC and local codes.
5. The Pro Logic is properly grounded and bonded.
6. The Pro Logic is properly configured to control all desired functions.

Program Automatic Operation

Refer to the programming flow chart on the back cover of this manual for a listing of the available menus and the items included in each menu.

Settings Menu

Heater and/or solar thermostat settings
Chlorinator settings
Day and Time

Timers Menu

Timeclock and/or Countdown timer settings

Heater Checkout

Follow these instructions to verify that the Pro Logic is properly controlling the heater.

1. Check that the Pro Logic is calling for the heater to turn on as indicated by the "Heater" LED being illuminated. If the "Heater" LED is illuminated, go directly to step 2; if not, then check the following:
 - The heater is enabled (Configuration Menu/Heater Config.).
 - The heater temperature setting is at least 2°F greater than the water temperature (Settings Menu / Pool Heater & Spa Heater).
 - The filter pump is running.
 - If the pool has solar heat and the solar priority feature is enabled (Configuration Menu/Solar Config) then solar must be off in order for the heater to fire. The easiest way to force solar off is to go to the Settings Menu / Pool Solar & Spa Solar and temporarily lower the temperature settings below the current water temperature.
2. Check that the heater is running. If not, then check:
 - Power is supplied to the heater.
 - The Pro Logic control output is properly connected to the heater control (see "Heater Control" wiring, page 15).
 - Some heaters also have internal switches or jumpers that have to be set correctly for remote control operation—refer to the heater manual and also "Heater Control" (page 15).
 - Heater is turned on ("Kill Switch" is in the "ON" position).
 - If a heater bypass valve is installed, check that water is flowing through the heater.
 - The heater temperature setting is set as high as possible (usually 104°F/40°C). Also note that some heat pumps actually have be set to the lowest possible temperature.
3. Once the heater is running, you can verify the "heater cooldown" feature (optional - see Configuration Menu/Heater Config.) is operating properly:
 - Press the "Filter" button once (for 2 speed pumps, this may require 2 pushes of the "Filter" button).



HAYWARD®

- The heater should turn off (“Heater” LED off) and the “Filter” LED will flash to indicate that heater cooldown is active.
- The display will periodically indicate that the filter pump is on for heater cooldown and show the minutes remaining.
- The pump will automatically turn off at the end of the 5 minute heater cooldown period.

For more detailed instructions on control and operation of the Pro Logic system, refer to the Operation Manual.

Service Mode

Service mode disables all automatic control operation and is intended to be used when servicing the pool system. To enter service mode, push the SERVICE button once on the main unit keypad. This will initially turn all outputs off and then allow you to turn outputs on/off manually at the main display (only). In service mode, the buttons on the optional remote display/keypad and the optional spa side remote will turn outputs off, but will not turn any output on. Heater control outputs and solar control outputs are prevented from turning on if the water temperature exceeds 104°F (40°C).

Pushing the SERVICE button again will enter a timed service mode. Service operation as described above will continue for 3 hours, then automatically return to normal operation.

Push the SERVICE button once more to exit out of Service mode.



HAYWARD®

LIMITED WARRANTY (effective 03/01/12) Hayward warrants its Pro Logic, OnCommand and E-Command pool automation products as well as its Aqua Rite, Aqua Rite Pro, Aqua Plus and SwimPure chlorination products to be free of defects in materials and workmanship, under normal use and service, for a period of three (3) years. Hayward also warrants its Aqua Trol chlorination products to be free of defects in materials and workmanship, under normal use and service for a period of one (1) year. These warranties are applicable from the initial date of purchase on private residential swimming pools in the US and Canada. Installations of product for use on commercial pools in the US and Canada is covered for a period of one (1) year for defects in materials and workmanship. Hayward warrants all accessories and replacement parts for the above-identified pool automation and chlorination products for a period of one (1) year. Accessories also include remotes, actuators, base stations, temperature sensors, flow switches and chemistry probes. Each of these warranties is not transferable and applies only to the original owner.

Hayward shall not be responsible for cartage, removal, repair or installation labor or any other such costs incurred in obtaining warranty replacements or repair.

Proof of purchase is required for warranty service. If written proof of purchase is not provided, the manufacturing date code will be the sole determinant of the date of installation of the product. To obtain warranty service or repair, please contact the place of purchase or the nearest Hayward authorized warranty service center. For more information on authorized service centers please contact the Hayward Technical Service Support Center (61 Whitecap Road, North Kingstown RI, 02852) or visit the Hayward web site at www.hayward.com.

WARRANTY EXCLUSIONS:

1. Material supplied or workmanship performed by others in process of installation.
2. Damage resulting from improper installation including installation on pools larger than the product rating.
3. Problems resulting from failure to install, operate or maintain the product(s) in accordance with the recommendations contained in the owners manual(s).
4. Problems resulting from failure to maintain pool water chemistry in accordance with the recommendations in the owners manual(s).
5. Problems resulting from tampering, accident, abuse, negligence, unauthorized repairs or alternations, fire, flood, lightning, freezing, external water, degradation of natural stone used in or immediately adjacent to a pool or spa, war or acts of God.
6. Use of a non-genuine Hayward replacement salt chlorination cell on any Hayward automation or chlorination product will void the warranty for that product.

The express limited warranty above constitutes the entire warranty of Hayward Pool Products with respect to its products and is in lieu of all other warranties expressed or implied, including warranties of merchantability or fitness for a particular purpose. In no event shall Hayward Pool products be responsible for any consequential, special or incidental damages of any nature. Some states do not allow a limitation on how long an implied warranty lasts, or the exclusion of incidental or consequential damages, so the above limitation may not apply to you. This warranty gives you specific legal rights, and you may also have other rights, which vary from state to state.



HAYWARD®

For further information or consumer
technical support, visit our website at
www.hayward.com



HAYWARD®



Hayward is a registered trademark and Pro Logic is a
trademark of Hayward Industries, Inc. © 2016 Hayward Industries, Inc.

All other trademarks not owned by Hayward are the property of their respective owners.
Hayward is not in any way affiliated with or endorsed by those third parties.

USE ONLY HAYWARD GENUINE REPLACEMENT PARTS